

The cover features a light gray background with several overlapping, semi-transparent circular shapes. A series of thin, dark gray lines curves across the middle of the page, starting from the left and ending on the right. The title 'LCD Monitor User Manual' is positioned on the left side of the cover.

# LCD Monitor User Manual

Please read this manual before use and retain it for future reference.  
Specifications are subject to change without notice.



# Safety Instructions

## Safety precautions and maintenance



**WARNING:** Use of controls, adjustments or procedures other than those specified in this documentation may result in exposure to shock, electrical hazards and/or mechanical hazards.

## Read and follow these instructions when connecting and using your display:

### Operation:

- Keep the display out of direct sunlight and away from stoves or any other heat sources.
- Keep the display away from oil, otherwise the plastic cover may be damaged.
- Remove any object that could fall into ventilation holes or prevent proper cooling of the display's electronics.
- Do not block the ventilation holes on the cabinet.
- When positioning the display, make sure the power plug and outlet are easily accessible.
- When turning off the display by detaching the power cord, wait 6 seconds before re-attaching the power cord for normal operation.
- Ensure the use of an approved power cord provided by DH at all times. If your power cord is missing, please contact your local service center.
- Do not subject the display to severe vibration or high impact conditions during operation.
- Do not knock or drop the display during operation or transportation.

### Maintenance:

- To protect your display from possible damage, do not put excessive pressure on the LCD panel. When moving your display, grasp the frame to lift; do not lift the display by placing your hand or fingers on the LCD panel.
- Unplug the display if you are not going to use it for an extensive period of time.
- Unplug the display if you need to clean it with a slightly damp cloth. The screen may be wiped with a dry cloth when the power is off. However, never use organic solvent, such as, alcohol, or ammonia-based liquids to clean your display.
- To avoid the risk of shock or permanent damage to the set, do not expose the display to dust, rain, water or an excessively moist environment.
- If your display becomes wet, wipe it with dry cloth as soon as possible.
- If a foreign substance or water gets in your display, turn the power off immediately and disconnect the power cord. Then remove the foreign substance or water, and send the unit to the maintenance center.
- Do not store or use the display in locations exposed to heat, direct sunlight or extreme cold.
- In order to maintain the best performance of your display and ensure a longer lifetime, we strongly recommend using the display in a location that falls within the following temperature and humidity ranges.
  - Temperature: 0-40°C 32-104°F
  - Humidity: 20-80% RH

**IMPORTANT:** Always activate a moving screen saver program when you leave your display unattended. Always activate a periodic screen refresh application if the unit will display unchanging static content. Uninterrupted display of still or static images over an extended period may cause “burn in”, also known as “after-imaging” or “ghost imaging”, on your screen. This is a well-known phenomenon in LCD panel technology. In most cases, the “burned in” or “after-imaging” or “ghost imaging” will disappear gradually over a period of time after the power has been switched off.

**WARNING:** Severe “burn-in” or “after-image” or “ghost image” symptoms will not disappear and cannot be repaired. This is also not covered under the terms of your warranty.

**Service:**

- The casing cover should be opened only by qualified service personnel.
- If there is any need for repair or integration, please contact your local service center.
- Do not leave your display under direct sunlight.



If your display does not operate normally, having followed the instructions set out in this document, please contact a technician or your local service center.

## Read and follow these instructions when connecting and using your display:



- Unplug the display if you are not going to use it for an extensive period of time.
- Unplug the display if you need to clean it with a slightly damp cloth. The screen may be wiped with a dry cloth when the power is off. However, never use alcohol, solvents or ammonia-based liquids.
- Consult a service technician if the display does not operate normally when you have followed the instructions in this manual.
- The casing cover should be opened only by qualified service personnel.
- Keep the display out of direct sunlight and away from stoves or any other heat sources.
- Remove any object that could fall into the vents or prevent proper cooling of the display's electronics.
- Do not block the ventilation holes on the cabinet.
- Keep the display dry. To avoid electric shock, do not expose it to rain or excessive moisture.
- When turning off the display by detaching the power cable or DC power cord, wait for 6 seconds before re-attaching the power cable or DC power cord for normal operation..
- To avoid the risk of shock or permanent damage to the set do not expose the display to rain or excessive moisture.
- When positioning the display, make sure the power plug and outlet are easily accessible.
- **IMPORTANT:** Always activate a screen saver program during your application. If a still image in high contrast remains on the screen for an extended period of time, it may leave an 'after-image' or 'ghost image' on the front of the screen. This is a well-known phenomenon that is caused by the shortcomings inherent in LCD technology. In most cases the afterimage will disappear gradually over a period of time after the power has been switched off. Be aware that the after-image symptom cannot be repaired and is not covered under warranty.

## CE Declaration of Conformity

This device complies with the requirements set out in the Council Directive on the Approximation of the Laws of the Member States relating to Electromagnetic Compatibility (2014/30/EU), Low-voltage Directive (2014/35/EU), RoHS directive (2011/65/EU) and Radio Equipment Directive (2014/53/EU).

This product has been tested and found to comply with the harmonized standards for Information Technology Equipment, these harmonized standards published under Directives of Official Journal of the European Union.

## Warning:

This equipment is compliant with Class A of EN55032/CISPR 32. In a residential environment this equipment may cause radio interference.

## ESD Warnings

When user close to the monitor may cause the equipment discharge and reboot to the display of main menu.

## Federal Communications Commission (FCC) Notice (U.S. Only)



NOTE: This equipment has been tested and found to comply with the limits for a Class A digital device, pursuant to part 15 of the FCC Rules. These limits are designed to provide reasonable protection against harmful interference when the equipment is operated in a commercial environment. This equipment generates, uses, and can radiate radio frequency energy and, if not installed and used in accordance with the instruction manual, may cause harmful interference to radio communications. Operation of this equipment in a residential area is likely to cause harmful interference in which case the user will be required to correct the interference at his own expense.



Changes or modifications not expressly approved by the party responsible for compliance could void the user's authority to operate the equipment.

Use only an RF shielded cable that was supplied with the display when connecting this display to a computer device.

To prevent damage which may result in fire or shock hazard, do not expose this appliance to rain or excessive moisture.

This device complies with Part 15 of the FCC Rules. Operation is subject to the following two conditions: (1) This device may not cause harmful interference, and (2) this device must accept any interference received, including interference that may cause undesired operation.

## Europe – EU Declaration of Conformity

This device complies with the essential requirements of the Radio Equipment Directive (2014/53/EU). The following test methods have been applied in order to prove presumption of conformity with the essential requirements of the Radio Equipment Directive (2014/53/EU):

- EN62368-1

Safety of Information Technology Equipment

- EN 62311

Assessment of electronic and electrical equipment related to human exposure restrictions for electromagnetic fields (0 Hz-300 GHz)

- EN 300 328 ( For 802.11b/g/n )

Electromagnetic compatibility and Radio spectrum Matters (ERM); Wideband Transmission systems; Data transmission equipment operating in the 2,4 GHz ISM band and using spread spectrum modulation techniques; Harmonized EN covering essential requirements under article 3.2 of the R&TTE Directive

- EN 301 489-17

Electromagnetic compatibility and Radio spectrum Matters (ERM); ElectroMagnetic

Compatibility (EMC) standard for radio equipment and services; Part 17: Specific conditions for 2,4 GHz wideband transmission systems and 5 GHz high performance RLAN equipment

- EN 301 489-1

Electromagnetic compatibility and Radio Spectrum Matters (ERM); ElectroMagnetic Compatibility (EMC) standard for radio equipment and services; Part 1: Common technical requirements

## **Canada:**

Industry Canada statement:

This device complies with RSS-247 of the Industry Canada Rules. Operation is subject to the following two conditions: (1) This device may not cause harmful interference, and (2) this device must accept any interference received, including interference that may cause undesired operation.

Ce dispositif est conforme à la norme CNR-247 d'Industrie Canada applicable aux appareils radio exempts de licence. Son fonctionnement est sujet aux deux conditions suivantes: (1) le dispositif ne doit pas produire de brouillage préjudiciable, et (2) ce dispositif doit accepter tout brouillage reçu, y compris un brouillage susceptible de provoquer un fonctionnement in

## **End-of-Life Disposal**

Your new Public Information Display contains materials that can be recycled and reused. Specialized companies can recycle your product to increase the amount of reusable materials and to minimize the amount to be disposed of.

Please find out about the local regulations on how to dispose of your old display from your local DH dealer.

## **(For customers in Canada and U.S.A.)**

This product may contain lead and/or mercury. Dispose of in accordance to local-state and federal regulations. For additional information on recycling contact [www.eia.org](http://www.eia.org) (Consumer Education Initiative)

## **Waste Electrical and Electronic Equipment-WEEE**

### **Attention users in European Union private households**



This marking on the product or on its packaging illustrates that, under European Directive 2012/19/EU governing used electrical and electronic appliances, this product may not be disposed of with normal household waste. You are responsible for disposal of this equipment through a designated waste electrical and electronic equipment collection. To determine the locations for dropping off such waste electrical and electronic, contact your local government office, the waste disposal organization that serves your household or the store at which you purchased the product.

### **Attention users in United States:**

Please dispose of according to all Local, State and Federal Laws. For the disposal or recycling information, contact: [www.mygreenelectronics.com](http://www.mygreenelectronics.com) or [www.eiae.org](http://www.eiae.org).

## End of Life Directives-Recycling



Your new Public Information Display contains several materials that can be recycled for new users.

Please dispose of according to all Local, State, and Federal laws

## Batteries



For EU: The crossed-out wheeled bin implies that used batteries should not be put to the general household waste! There is a separate collection system for used batteries, to allow proper treatment and recycling in accordance with legislation.

Please contact your local authority for details on the collection and recycling schemes.

For Switzerland: The used battery is to be returned to the selling point.

For other non-EU countries: Please contact your local authority for correct method of disposal of the used battery.

According to EU directive 2006/66/EC, the battery can't be disposed improperly. The battery shall be separated to collect by local service.

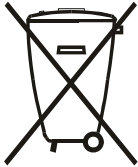

Após o uso, as pilhas e/ou baterias deverão ser entregues ao estabelecimento comercial ou rede de assistência técnica autorizada.



# Table of contents

1.	Unpacking and installation .....	1	5.	Compatibility of the USB device .....	20
1.1.	Unpacking.....	1	6.	Input mode .....	23
1.2.	Items in the packing case .....	1	7.	Cleaning and Troubleshooting. ....	24
1.3.	Installation precautions .....	1	7.1.	Cleaning .....	24
1.4.	Installation for the base of the mounting desk: .....	2	7.2.	Troubleshooting .....	25
1.5.	Hang the monitor on the wall....	3	8.	Technical specification.....	27
1.5.1.	VESA grid plate.....	3			
2.	Parts and functions.....	5			
2.1.	Control panel .....	5			
2.2.	Input/output terminal .....	6			
2.3.	Remote Control .....	7			
2.3.1.	General functions.....	7			
2.3.2.	Install batteries into the remote control.....	8			
2.3.3.	Maintenance of the remote control .....	8			
2.3.4.	Working scope of the remote control .....	9			
3.	Connect external devices .....	10			
3.1.	Connect external devices (DVD/VCR/NVR) .....	10			
3.1.1.	Use HDMI video input.....	10			
3.2.	Connect PC .....	10			
3.2.1.	Use HDMI input.....	10			
3.2.2.	Use VGA input .....	11			
3.3.	Connect USB .....	11			
3.3.1.	Use USB device .....	11			
4.	Operation.....	12			
4.1.	Play multimedia files from USB device .....	12			
4.1.1.	Photo.....	13			
4.1.2.	Music.....	14			
4.1.3.	Movie .....	15			
4.1.4.	Text .....	16			
4.2.	Operation on the OSD menu: ..	17			

The appearance and the color of the product are subject to the material object. The picture is for reference only.

## 1. Unpacking and installation

### 1.1. Unpacking

- This product is packed in a paper packing case and comes with standard accessories.
- Any other optional parts are individually packed.
- Considering the size and weight of the monitor, it is recommended to move this monitor by two persons.
- Please confirm that items are complete and intact after opening the packing case.

### 1.2. Items in the packing case

Please confirm that the packing case contains the following items:

- LCD monitor
- Remote control
- Instructions
- Power cord
- HDMI cable
- Bracket x 2



\* The supplied power cord varies depending on destination.



Remote Control



User Manual

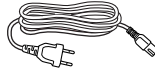

Power Cord



HDMI Cable



Bracket

Notes:

- For all other regions, the power cords shall be matched with the AC voltage of the power socket, conform to the regulations of the relevant laws of the countries/territories, and pass certification. (Types H05VV-F, 2G or 3G 0.75 or 1mm<sup>2</sup> shall be used.)
- You can keep the packing case and packaging materials for later transport of the monitor.

### 1.3. Installation precautions

- This product belongs to high-power-consumption products. Please always use the plug specially designed for this product. If you need to extend the wire, please consult your service provider.
- This product should be installed on a plane to avoid overturn. The rear part of this product should be kept away from the wall at a certain distance so as to maintain proper ventilation. This product shall not be installed in the kitchen, bathroom or any other locations with high humidity, to avoid shortening the service life of the electronic components.
- This product works only at an altitude below 3000m. If the installation site is higher than 3000m, some abnormalities may occur.

## 1.4. Installation for the base of the mounting desk:

### Install the base:

1. Spread the protective film (wrapped on the monitor during packing) on the desk, and place the monitor with its front face down on the protective film (keep the trademark off the desk) to avoid scratching the screen.
2. Align the base according to the figure (distinguish the left and right supports). There are R and L marks on the base. Lock screws.
3. Lift the monitor and place it.

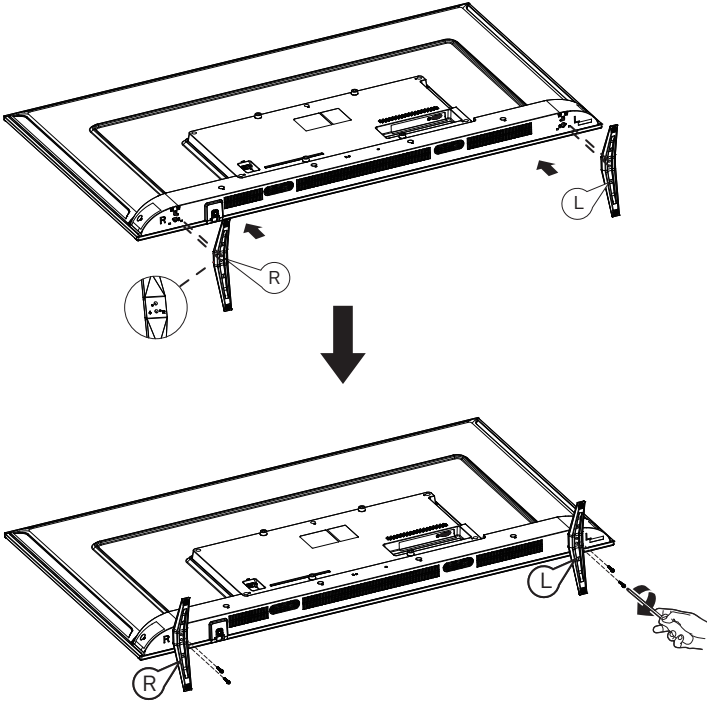

## 1.5. Hang the monitor on the wall

In order to install the monitor on the wall, you must prepare a set of standard wall-hanging kit (separately purchased). You are recommended to use the mounting plate which conforms to the TUV-GS and/or UL1678 standard.

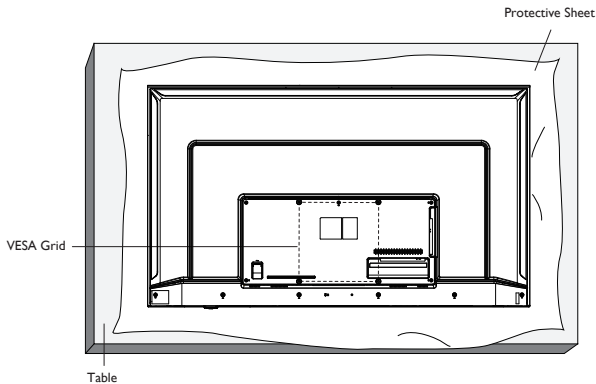

1. Spread a protective sheet which was wrapped around the display when it was packed on a flat surface. Lay the display face-down on the protective sheet to facilitate your operation without scratching the screen.
2. Ensure that you have all accessories necessary for any type of mounting (hanging rack, lifting rack, desk base, etc.).
3. Follow the instructions that come with the base mounting kit. Failure to follow correct mounting procedures could result in damage to the equipment or injury to the user or installer. Product warranty does not cover damage caused by improper installation.
4. For the wall-mounting kit, use M6 mounting screws (with a length 20 mm(50")/25mm(65") longer than the thickness of the mounting bracket) and tighten them securely.

### 1.5.1. VESA grid plate

50"	200(H) x 200(V) mm
65"	300(H) x 300(V) mm

#### Caution:

Prevent the monitor from falling down:

- In the case of wall installation or suspended installation, it is recommended to use the metal assembling rack available on the market to install the monitor. Refer to the guide attached to the assembling rack for specific installation instructions.
- In order to lower the probability that the monitor falls down and results in personal injuries and property loss under the condition of earthquake or other natural disasters, please do consult the assembling rack manufacturer to confirm the installation position.

### Ventilation requirements for enclosed space

In order to ensure normal heat dissipation, sufficient space from items to four sides shall be kept, as shown in the figure below.

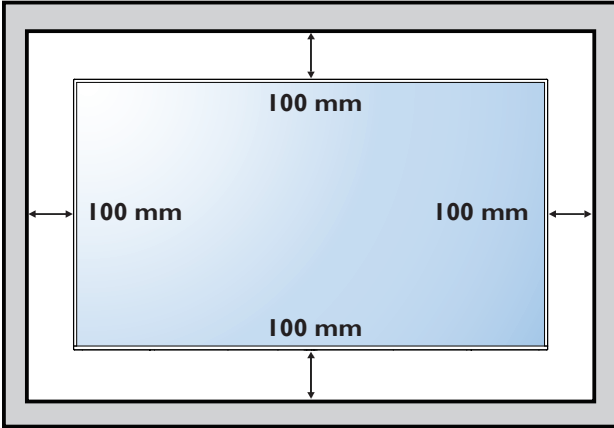

## 2. Parts and functions

### 2.1. Control panel

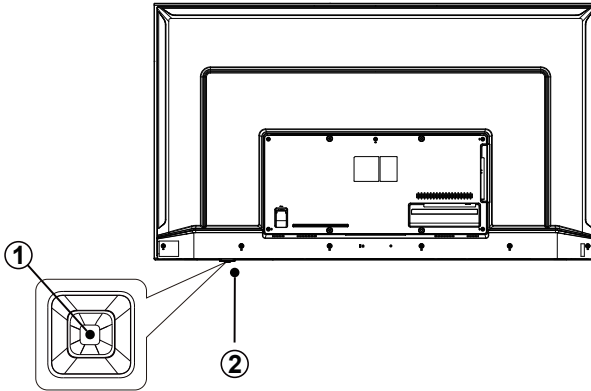

**① Power button**

Turn the display On or put the display to standby mode.

**② Remote control sensor and power status indicator.**

## 2.2. Input/output terminal

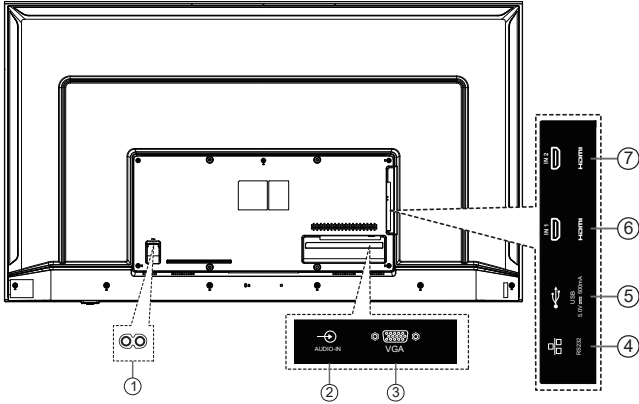

- ① **AC IN**  
AC power input from the wall socket.
- ② **AUDIO IN**  
Audio input for VGA source
- ③ **VGA IN**  
VGA video input.
- ④ **RS232**  
Receive command signals from the external RS232 device.
- ⑤ **USB port**  
Connect to the USB storage device.
- ⑥ **HDMI 1/** ⑦ **HDMI 2**  
HDMI 1 support HDMI 1.4, up to 4K @30Hz.  
HDMI 2 support HDMI 2.0, up to 4K @60Hz.

## 2.3. Remote Control

### 2.3.1. General functions

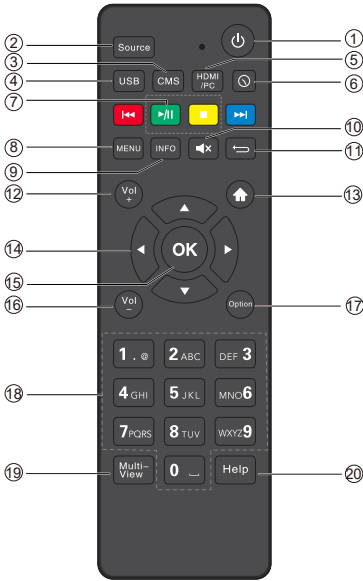

- ① **[POWER] button**  
Turn OFF the display until power is off.
- ② **[Source] Button**  
Channel switching, source key only supports switching (source).
- ③ **[CMS] button**  
Reserved.
- ④ **[USB] button**  
Go to USB source.
- ⑤ **[HDMI/PC] button**  
Go to HDMI source.
- ⑥ **[Time] button**  
Reserved.
- ⑦ **[PLAY] button**  
Control playback of media files.

- ⑧ **[MENU] SETTINGS button**  
Enter the main menu, or return to previous menu or exit the main menu. The remote control buttons [up], [down], [left], [right] are movement, Under the menu setting, press the left and right buttons to enter the lower menu or adjust the parameters.
- ⑨ **[INFO] button**  
Show Information OSD.
- ⑩ **[MUTE] button**  
Mute or restore volume.
- ⑪ **[BACK] button**  
Signal source interface or menu interface: prompt "exit" and press RC [return] to exit.
- ⑫ **[Vol+]VOLUME button**  
Turn up the volume.
- ⑬ **[HOME] button**  
Reserved.
- ⑭ **[▲] [▼] [◀] [▶] NAVIGATION buttons**  
Up, down, left and right operation key.
- ⑮ **[OK] button**  
Press OK to display the message.
- ⑯ **[Vol-] Volume button**  
Turn Down the volume.
- ⑰ **[Option] button**  
Reserved.
- ⑱ **[Number] buttons**  
Input figures or text.
- ⑲ **[Multi-View] button**  
Reserved.
- ⑳ **[Help] button**  
Reserved.



### 2.3.2. Install batteries into the remote control

The remote control is electrified by two pieces of 1.5V AAA batteries.

Install or replace batteries:

1. Install and push away the battery cover.
2. Place the batteries according to the marks (+) and (-).
3. Close the battery cover.

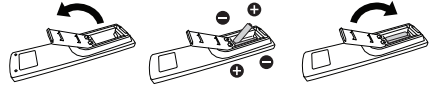

#### Caution:

Incorrect use of the batteries may result in liquid leak or explosion. Please do abide by the following instructions:

- To place the "AAA" batteries in, the marks (+) and (-) of each of the batteries shall correspond to the marks (+) and (-) in the battery compartment.
- Please do not use batteries of different types at the same time.
- Please do not use old and new batteries at the same time, otherwise the service life of the batteries will be shortened or liquid leak will occur.
- Take out the batteries immediately once the batteries are exhausted so as to avoid liquid leak in the battery compartment.  
Please do not touch exposed acid liquid of the batteries, or your skin will be injured.

Notes: Take out the batteries if the remote control is not used for a long time.

### 2.3.3. Maintenance of the remote control

- Protect the remote control against violent collision.
- Do not splash water or other liquid on the remote control. Wipe dry the remote control immediately if there is liquid thereon.
- Keep it away from heat and damp.
- Do not open the remote control except installing the batteries.

## 2.3.4. Working scope of the remote control

To press buttons on the remote control, please point the front of the remote control at the remote sensor on the monitor.

When the remote control is in use, the distance to the sensor on the monitor shall be smaller than 5m/16 inch, and the horizontal and vertical angles shall be smaller than 30 degrees.

Notes: The remote control may fail to work normally when sunlight or other strong light radiates on the remote sensor of the monitor or there is an obstacle between the remote and the remote sensor.

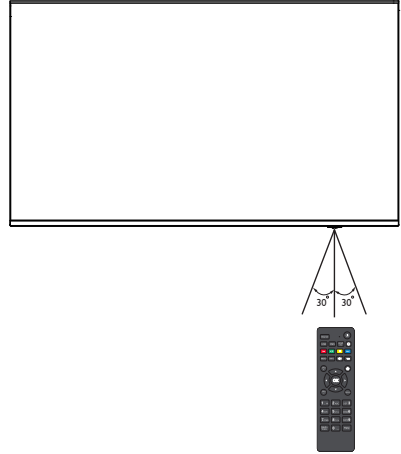

### 3. Connect external devices

#### 3.1. Connect external devices (DVD/VCR/NVR)

##### 3.1.1. Use HDMI video input

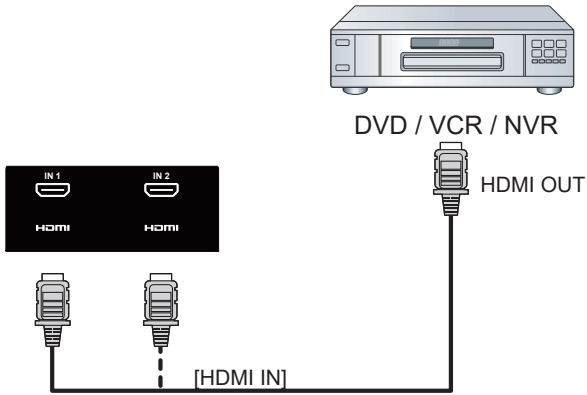

#### 3.2. Connect PC

##### 3.2.1. Use HDMI input

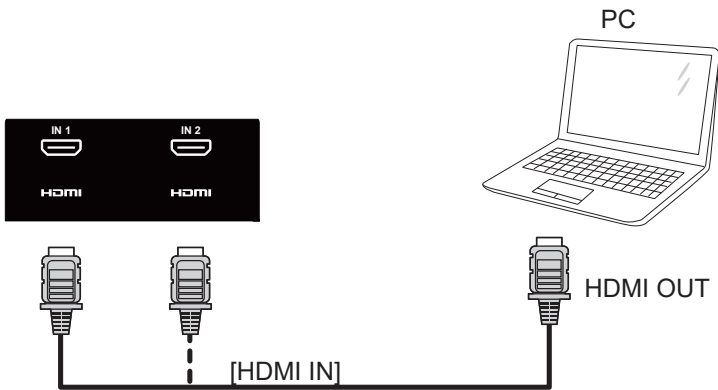

### 3.2.2. Use VGA input

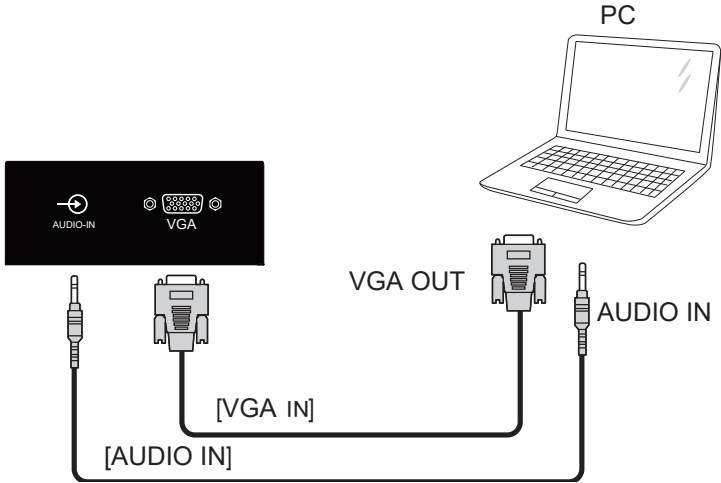

### 3.3. Connect USB

#### 3.3.1. Use USB device

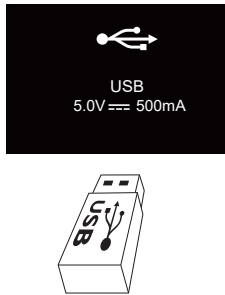

## 4. Operation

**NOTE:** The control button described in this section is mainly on the remote control unless specified otherwise.

### 4.1. Play multimedia files from USB device

1. Connect your USB device to the USB port on the display.

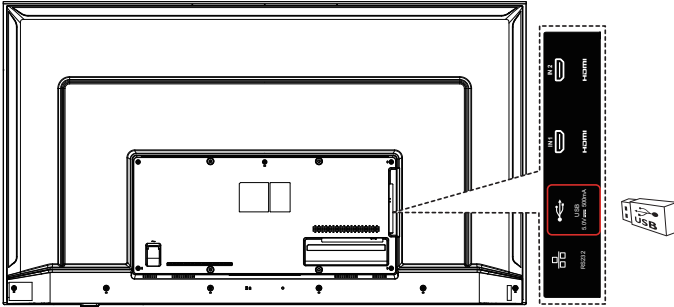

2. Press **SOURCE** button, choose **USB**, and press [ **OK** ] button.

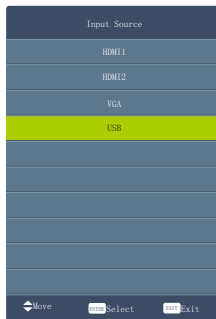

3. Press ◀▶ to select **Photo/Music/Movie/Text** icon and **OK** to enter the USB memory.

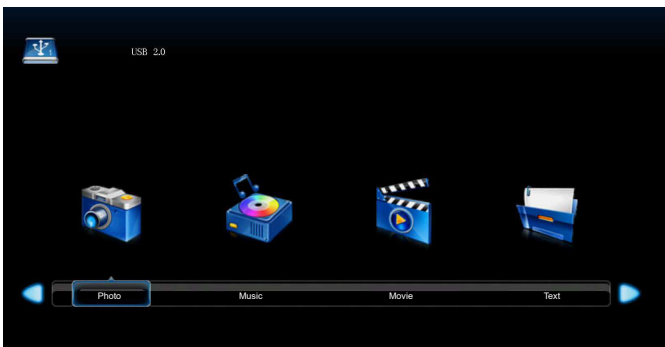

4. Follow the on-screen instruction to control the play option.

### 4.1.1. Photo

Select a picture file and press **OK** to view, and it will display all the pictures in the folder automatically. Press **OK** to display the following menu.

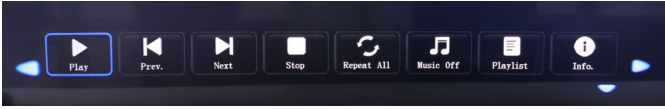

<b>Play/Pause</b>	Press "Play/Pause" button to paly or pause the slideshow.
<b>Next/Prev.</b>	Press "Next/Prev." button to skip to view the photo which are selecd the photo.
<b>Stop</b>	Press "Stop" button to stop and return.
<b>RepeatAll</b>	Press to select the repeat mode: Repeat 1/ALL/None.
<b>Music</b>	Press to play or stop the background music.
<b>Playlist</b>	Press to view the list of pictures.
<b>Info.</b>	Press to display the information of the current picture (Resolution/ Size/Date/Time)
<b>Rotate</b>	Rotate counterclockwise.
<b>Zoom in</b>	Zoom the picture in.
<b>Zoom out</b>	Zoom the picture out.
<b>Move view</b>	Zoom out the picture first. Highlight the icon and press OK, then press ▼/▲& ◀/▶ to move the picture.
<b>Capture</b>	Press to set the selected picture as the boot logo. (Available for select model)

## 4.1.2. Music



<b>Play/Pause</b>	Press to play or stop.
<b>FB</b>	Press to play slower.
<b>FF</b>	Press to play faster.
<b>Prev.</b>	Press to play the previous song.
<b>Next</b>	Press to play the next song.
<b>Stop</b>	Press to stop and return to folder interface.
<b>RepeatAll</b>	Press to select the repeat mode: Repeat 1/ALL/None.
<b>SET A</b>	Select AB mode.
<b>Mute</b>	Select "MUTE" mode: on or off .
<b>Playlist</b>	Seclect to display play list.
<b>INFO.</b>	Seclect to display the music information.
<b>Goto time</b>	Seclect to setup play time.

### 4.1.3. Movie

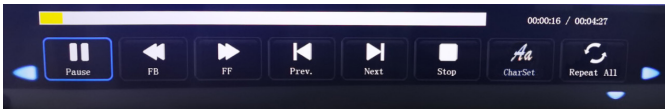

<b>Play/Pause</b>	Press to play or pause.
<b>FB</b>	Press to play slower.
<b>FF</b>	Press to play faster.
<b>Prev.</b>	Press to play the previous movie.
<b>Next</b>	Press to play the next movie.
<b>Stop</b>	Press to stop and back to folder interface.
<b>RepeatAll</b>	Press to select the repeat mode: Repeat 1/ALL/None.
<b>Set A</b>	Select AB mode.
<b>Charset</b>	Character set switching.
<b>Playlist</b>	Press to view the list of pictures.
<b>INFO.</b>	Press to display the information of the current movie.
<b>Slow forward</b>	Slow forward.
<b>Step forward</b>	Step forward.
<b>Goto time</b>	Select to setup play time.



#### 4.1.4. Text

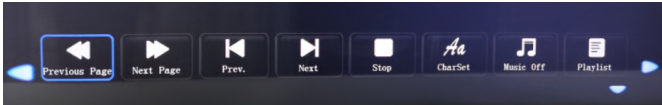

<b>Prev Page</b>	Press to the previous page.
<b>Next Page</b>	Press to the next page.
<b>Prev.</b>	Press to play previous text.
<b>Next</b>	Press to play next text.
<b>Stop</b>	Press to stop and back to folder interface.
<b>Charset</b>	Character set switching.
<b>Music</b>	Turn background music on or off.
<b>Playlist</b>	Press to view the list of texts.
<b>INFO.</b>	Press to display the information of the current movie.

## 4.2. Operation on the OSD menu:

Column 1	Column 2	Column 1, 3	Column 2, 3 or Column 2, 2	Remarks
Picture	Picture Mode	Security monitoring		Depend on HDMI 1/ HDMI 2
		Automatic		Depend on HDMI 1/ HDMI 2
		Bright		
		Standard		
		Soft		
		User		Sub items can be adjusted in user mode only, Grayed out in other modes.
	Color temp	Standard (9300K)		Adjust different image modes, the default color temperature is the standard.(only user mode can be adjusted, other modes are grayed out)
		Warm (6500K)		
		User		
		Cool (12000K)		
	Noise Reduction	Off		1. It is not adjustable in computer channel or security monitoring mode, and the display proportion is point-to-point. 2. When entering video timing, noise suppression is adjustable. 3. USB source playing video noise is adjustable.
		Low		
		Middle		
		High		
		Default		
	Brightness	0 ... 100		Backlight adjustment.
	HDMI Mode	Auto		The reappearance rate is different under different separation rate and mode.
Video				
PC				
Sound	Treble	0 ... 100	50: default	In mute mode, when you press the key to adjust the sound and balance, the mute icon will disappear.
	Bass	0 ... 100	50: default	
	Balance	-50 ... +50	0: default	

TIME	Sleep Timer	Off, 10min, 20min, 30min, 60min, 90min, 120min, 180min, 240min		After setting the time, the device will automatically turn off at the time you set. Restart and return to the default value of off.
	Auto Sleep	Off, 3 hours, 4 hours, 5 hours		Turn off or select no device operation to automatically enter sleep time (3 hours, 4 hours, 5 hours). Default value: turn off.
	OSD Timer	5S / 10s / 15s / 20s / 25s / 30s		Set OSD disappear time.
OPTION	OSD Language	English		Set the OSD display language.
		Chinese		
	Color Range	Auto		VGA, USB source graying is not optional.
		0-255		
		16-235		
	Aspect Ratio	Auto		VGA signal: 4:3 / 16:9 / PointToPoint. Note: options are different for different channels, input signal formats and image modes. USB channel does not support proportional mode.
		16:9		
		4:3		
		Zoom1		
		Zoom2		
Blue Screen	Just Scan			
	Panorama			
	PointToPoint			
Blue Screen	On/Off		After the blue screen is opened, the no signal interface and menu interface display the blue background.	
Restore Factory Default			Recall the default setting.	
Soft Update (USB)			software to Update	

SCREEN	Auto Adjust			<p>Note: 1. The VGA signal is not connected, so the screen menu cannot be selected; 2. Press up / down key to switch in the process of horizontal position / vertical position / clock / phase adjustment value.</p> <p>When VGA is in the pop-up interface of the automatic adjustment mode, the remote control and the power key have no effect, and the pop-up interface disappears and the system will shut down normally.</p>
	Position H.			
	Position V.			
	Size			
	Phase			
	Position Reset			

Note: Some options may vary for different signals and models, please subject to the actual machine.

## 5. Compatibility of the USB device

### Format of the USB multi-media coder-decoder

Spec of AV codec , Video					
Type	Video coder-decoder	Highest bit rate	Frame rate	Resolution	Audio format
AVI(.avi)	MPEG-1,	80Mbps	30FPS	1920x1080	MPEG-1 Layers I,II, III(MP3) AAC, AC3, PCM, WMA, WMAPro
	MPEG-2MP@HL,	80Mbps	30FPS	1920x1080	
	MPEG-4 SP@L0-3, ASP@L0-5,	50Mbps	30FPS	1920x1080	
	H.264 MP,HP@Level4.1,	100Mbps(VCL) 120Mbps(NAL)	30FPS	3840x2160	
	VC1 (AP),	45Mbps	30FPS	1920x1080	
	H263,	5Mbps	30FPS	1280x720	
	MJPEG,		30FPS	1920x1080	
MPEG-2 TS Transport Stream(. ts)	MPEG-2MP@HL,	80Mbps	30FPS	1920x1080	MP3 AAC AC3 PCM
	MPEG-4SP@L0- 3,ASP@L0-5,	50Mbps	30FPS	1920x1080	
	H.264 MP,HP@Level4.1,	100Mbps(VCL) 120Mbps(NAL)	30FPS	3840x2160	
	AVS benchmark grade@level 6.0,	50Mbps	30FPS	1920x1080	
	VC1 (AP),	45Mbps	30FPS	1920x1080	
	H265	100Mbps	30FPS	3840x2160	
MPEG File Format (.mpeg)	MPEG-1,	80Mbps	30FPS	1920x1080	PCM, AC3, MP3
	MPEG-2MP@HL,	80Mbps	30FPS	1920x1080	
	H.264 MP,HP@Level 4.1,	100Mbps(VCL) 120Mbps(NAL)	30FPS	3840x2160	
	H.264 MP,HP@Level 4.1,	100Mbps(VCL) 120Mbps(NAL)	30FPS	3840x2160	
	MPEG- 4SP@L0-3, ASP@L0-5,	50Mbps	30FPS	1920x1080	
	H265	100Mbps	30FPS	3840x2160	
QuickTime (.mov)	H.264 MP,HP@Level 4.1,	100Mbps(VCL) 120Mbps(NAL)	30FPS	3840x2160	AAC
	MPEG- 4SP@L0-3, ASP@L0-5,	50Mbps	30FPS	1920x1080	
	MJPEG,		30FPS	1920x1080	
	H265	100Mbps	30FPS	3840x2160	

BDAV MPEG-2 transport stream (.m2ts)	H.264 MP,HP@Level 4.1,	100Mbps(VCL) 120Mbps(NAL)	30FPS	3840x2160	AC3, AAC,
	VC1 (AP),	45Mbps	30FPS	1920x1080	
	MPEG-2MP@HL,	80Mbps	30FPS	1920x1080	
Matroska (.mkv)	H.264 MP,HP@Level 4.1,	100Mbps(VCL) 120Mbps(NAL)	30FPS	3840x2160	
	VC1 (AP),	45Mbps	30FPS	1920x1080	
	H265	100Mbps	30FPS	3840x2160	
Flash Video (.flv)	H.264 MP,HP@Level 4.1,	100Mbps(VCL) 120Mbps(NAL)	30FPS	3840x2160	AAC, MP3
	H263	5Mbps	30FPS	1280x720	
Video Object (.vob)	MPEG-2MP@HL,	80Mbps	30FPS	1920x1080	AC3 PCM MP3
DAT (.dat)	MPEG-1,	80Mbps	30FPS	1920x1080	PCM MP3
Advanced Stream Format (.asf)	VC1 (AP),	45Mbps	30FPS	1920x1080	MP3
	H.264 MP,HP@Level 4.1,	100Mbps(VCL) 120Mbps(NAL)	30FPS	3840x2160	PCM WMA
	MPEG- 4SP@L0-3, ASP@L0-5,	50Mbps	30FPS	1920x1080	
3gp	H.264 MP,HP@Level 4.1,	100Mbps(VCL) 120Mbps(NAL)	30FPS	3840x2160	AMR_NB, AAC
	H263	5Mbps	30FPS	1280x720	
	MPEG- 4SP@L0-3, ASP@L0-5,	50Mbps	30FPS	1920x1080	
tp	MPEG-2MP@HL,	80Mbps	30FPS	1920x1080	MPEG-1 Layers II, AC3
trp	H.264 MP,HP@Level 4.1,	100Mbps(VCL) 120Mbps(NAL)	30FPS	3840x2160	MP3
	MPEG-2MP@HL,	80Mbps	30FPS	1920x1080	

Spec of AV codec , Audio			
Type	Audio format	Sampling Rate	Bit rate
Windows Media Audio (.wma)	WMA WMAPro	8KHz ~ 48KHz	128bps ~ 320Kbps
MPEG Audio Layer III (.mp3)	MPEG	32kHz ~ 48kHz	32kbps ~ 320kbps
Advanced Audio Coding (.aac)	AAC	16kHz ~ 48kHz	24kbps ~ 384kbps
N/A (Work with video files only)	AC3	32kHz, 44.1kHz, 48kHz	32kbps ~ 640kbps
	EAC3	32kHz, 44.1kHz, 48kHz	32Kbps ~ 6 Mbps
OGG Vorbis (.ogg)	Vorbis	8kHz~48kHz	max 320Kbps

Spec of AV codec , Photo		
Type	Maximum resolution	Minimum resolution
png	8K*8K (Hardware solutions)	4*4
jpeg	baseline 8K*8K, (Hardware solutions) progressive 4K*4K	4*4
bmp	8K*8K	4*4

Notes:

- If the standard bite rate/frame rate of the contents is higher than the compatible frames/ second listed in the above table, audio or video may not work.
- Video contents with a bit rate or frame rate higher than the designated rate in the above table may result in discontinuation of video during display.

## 6. Input mode

### PC mode

- 720 x 400 @ 70Hz
- 640 x 480 @ 60Hz
- 640 x 480 @ 75Hz
- 800 x 600 @ 60Hz
- 1024 x 768 @ 60Hz
- 1152 x 870 @ 75Hz
- 1280 x 720 @ 60Hz
- 1280 x 1024 @ 60Hz
- 1366 x 768 @ 60Hz
- 1920 x 1080 @ 60Hz
- 1600 x 900 @ 60Hz
- 1680 x 1050 @ 60Hz
- 1600 x 1200 @ 60Hz

### Video mode

- 480P - 60Hz
- 480i - 60Hz
- 576P - 50Hz
- 576i - 50Hz
- 720P - 50Hz/60Hz
- 1080P - 50/60Hz
- 1080i - 50/60Hz
- 4K2K - 30Hz
- 4K2K - 60Hz



## 7. Cleaning and Troubleshooting

### 7.1. Cleaning

#### Caution When Using the Display

- Do not bring your hands, face or objects close to the ventilation holes of the display. The top of the display is usually very hot due to the high temperature of exhaust air being released through the ventilation holes. Burns or personal injuries may occur if any body parts are brought too close. Placing any object near the top of the display could also result in heat related damage to the object as well as the display itself.
- Be sure to disconnect all cables before moving the display. Moving the display with its cables attached may damage the cables and thus cause fire or electric shock.
- Disconnect the power plug from the wall outlet as a safety precaution before carrying out any type of cleaning or maintenance procedure.

#### Front Panel Cleaning Instructions

- The front of the display has been specially treated. Wipe the surface gently using only a cleaning cloth or a soft, lint-free cloth.
- If the surface becomes dirty, soak a soft, lint-free cloth in a mild detergent solution. Wring the cloth to remove excess liquid. Wipe the surface of the display to remove dirt. Then use a dry cloth of the same type to dry.
- Do not scratch or hit the surface of the panel with fingers or hard objects of any kind.
- Do not use volatile substances such as insert sprays, solvents and thinners.

#### Cabinet Cleaning Instructions

- If the cabinet becomes dirty, wipe the cabinet with a soft, dry cloth.
- If the cabinet is extremely dirty, soak a lint-free cloth in a mild detergent solution. Wring the cloth to remove as much moisture as possible. Wipe the cabinet. Use another dry cloth to wipe over until the surface is dry.
- Do not use solution that contains oil to clean the plastic parts. Such product damage the plastic parts and void the warranty.
- Do not allow any water or detergent to come into contact with the surface of the display. If water or moisture gets inside the unit, operating problems, electrical and shock hazards may result.
- Do not scratch or hit the cabinet with fingers or hard objects of any kind.
- Do not use volatile substances such as insert sprays, solvents and thinners on the cabinet.
- Do not place anything made from rubber or PVC near the cabinet for any extended periods of time.

## 7.2. Troubleshooting

Symptom	Possible cause	Solution
<b>No display</b>	<ol style="list-style-type: none"> <li>1. The power cord has been disconnected.</li> <li>2. The main power switch on the back of the monitor is not turned on.</li> <li>3. The selected input is not connected.</li> <li>4. The monitor is in the standby mode.</li> </ol>	<ol style="list-style-type: none"> <li>1. Plug the power cord.</li> <li>2. Make sure the power switch is turned on.</li> <li>3. Link signals to the monitor.</li> </ol>
<b>The monitor receives interference or noise can be heard..</b>	This is caused by the surrounding electrical devices or fluorescent light.	Move the monitor to other positions to check if the interference is reduced.
<b>Abnormal color</b>	The signal wire is not correctly connected.	Make sure the signal wire is firmly connected to the rear of the monitor.
<b>The display is twisted, and there are abnormal patterns.</b>	<ol style="list-style-type: none"> <li>1. The signal wire is not correctly connected.</li> <li>2. The input signal is beyond the capability of the monitor.</li> </ol>	<ol style="list-style-type: none"> <li>1. Make sure the signal wire is firmly connected.</li> <li>2. Check if the video signal source is beyond the range of the monitor. Please check the specification of the monitor against its specifications.</li> </ol>
<b>The displayed picture does not cover the whole screen.</b>	<ol style="list-style-type: none"> <li>1. The aspect ratio is incorrect.</li> <li>2. The scanning mode may be incorrectly set in Underscan.</li> <li>3. If the picture size exceeds the screen size, the scanning mode may need to be set to be Underscan.</li> </ol>	Use the aspect ratio in the screen menu or the self-set zooming function to tune the geometric shape of the screen and the clock frequency parameter.
<b>There is sound, but no picture.</b>	The input source signal wire is incorrectly connected.	Make sure video input and voice input are both correctly connected.

<p><b>There is picture, but no sound.</b></p>	<ol style="list-style-type: none"> <li>1. The input source signal wire is incorrectly connected.</li> <li>2. The volume is minimized.</li> <li>3. {Mute} has been enabled.</li> <li>4. The external loudspeaker is not connected.</li> </ol>	<ol style="list-style-type: none"> <li>1. Make sure video input and voice input are both correctly connected.</li> <li>2. Use [<b>+</b>] or [<b>-</b>] button to adjust the volume.</li> <li>3. Use [<b>Mx</b>] button to disable Mute.</li> <li>4. Connect the external loudspeaker and adjust the volume to a proper level.</li> </ol>
<p><b>Some picture elements are dim.</b></p>	<p>Some pixels on the screen may be not activated.</p>	<p>This monitor is made by very high precision technology. However, sometimes, some pixels on the monitor may still be not displayed. This is not a failure.</p>
<p><b>There is picture retention on the monitor display after the monitor is powered off. (Examples of motionless pictures include: icon, video game, computer image, and pictures displayed in 4:3 standard mode.)</b></p>	<p>Too long display of the motionless picture</p>	<p>Never display the motionless picture for a long time, or the monitor will have permanent picture retention.</p>

## 8. Technical specification

Item	Specification	
	50"	65"
Screen size (effective area)	49.5 inch (126 cm) diagonal line LCD	64.5 inch (163.9 cm) diagonal line LCD
Aspect ratio	16:9	16:9
Pixel number	3840 (H) x 2160 (V)	3840 (H) x 2160 (V)
Dot Spacing	0.2854 (H) x 0.2854 (V) [mm]	0.372 (H) x 0.372 (V) [mm]
Displayable color	8bits+FRC 1.07G Color	8bits+FRC 1.07G Color
Brightness (classic)	300 cd/m <sup>2</sup> (classic)	350 cd/m <sup>2</sup> (classic)
Contrast (classic)	5000:1	1200:1
Visual angle	178 (Typ.)	178 (Typ.)

### Input/output terminal:

Item		Specification
Loudspeaker output	Internal loudspeaker	7 W (L) + 7 W (R) [RMS]/6 Ω
Audio input	3.5Mm Headphone jack x 1	0.5V [rms]( normal mode) / 2 sound track (L+R)
VGA input	D-SUB jack (15pin)	Analog RGB: 0.7V [p-p] (75Ω), H/CS/V: TTL (2.2kΩ), MAX: 1920 x 1080/60 Hz (WUXGA)
HDMI input	HDMI interface x 2 (A type) (19 pins)	Digit RGB: TMDS (video + audio setting) Max.: Video – HDMI 1 4K@30Hz HDMI 2 4K@60Hz Audio - 48 KHz/ 2 sound track (L+R) Support LPCM only
USB input	USB2.0 A type x1	USB2.0
RS232	RJ-45 Jack x 1 (8 pin)	RS232 in

**General:**

Item	Specification	
	50"	65"
Power input	100-240V~, 50/60Hz	100-240V~, 50/60Hz
Power consumption (max.)	110 W	190 W
Power consumption (classic)	90 W	160 W
Power consumption (standby and power-off)	<0.5 W	<0.5 W
Dimension (without base) [W x H x D]	1113.0 X 649.0 X 87.2 mm	1449.6 X 844.7 X 78.6 mm
Dimension (with base) [W x H x D]	1113.0 X 710.5 X 247.9 mm	1449.6 X 883.4 X 283.4 mm
Net weight (without base)	10.41 Kg	18.6 Kg
Net weight (with base)	10.65 Kg	18.75 Kg

**Environmental conditions:**

Item		Specification
Temperature	Running	0 ~ 40°C
	Storage	-20 ~ 60°C
Temperature	Running	20 ~ 80% RH (no dew)
	Storage	10 ~ 90% RH (no dew)
Altitude	Running	0 ~ 3,000 m
	Storage/transport	0 ~ 9,000 m







Q41G65M107806B